

Article number: 20127468

Description: E+G Ball knob DIN 319-ST-50-M12-C

Measures

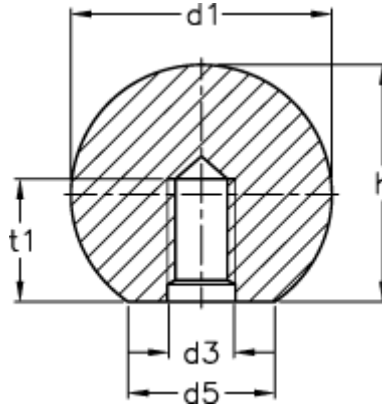

d1	= 50
d3	= M12
d5	= 27
h	= 46.0
t1 min.	= 21.0